

SimBaby

Directions for Use



Cautions and Warnings

Laerdal SimBaby should be operated by trained persons. Treat SimBaby as you would treat a real patient. A general inspection should be conducted regularly. Do not use the product if cables or tubings have signs of damage.

Students should wash their hands prior to using the simulator and wear gloves.

Use on clean surface only. Avoid felt tipped markers, ink pens, acetone, iodine or other staining medications, and placing the manikin on newsprint or inked lines of any kind. Do not allow the manikin's skin to come in direct contact with ink or photocopied paper, as this can permanently stain the skin. Mouth-to-mouth/nose/mask ventilation shall not be performed on SimBaby due to cleaning issues. Do not introduce any fluids into the torso area or left (BP) arm of the manikin, as electronic components can be damaged. Do not introduce any fluids (except airway lubricant in small amounts to lubricate the airway adjuncts) into the esophagus or trachea of the manikin. After each session involving airway lubricant the esophagus filter must be replaced. See "Maintenance" for more information. If a training session involves the administration of fluids and/or drugs into the IV arm and IO/IV legs, empty the arm and legs immediately following the training session.

Use of a defibrillator for training purposes represents an operational hazard equivalent to use of a defibrillator on a real patient since it involves the release of high levels of electrical energy into the training manikin.

Consequently:

All safety precautions for use of defibrillators must be followed, as if the manikin were a patient. Consult your defibrillator's User Manual.

- Defibrillation should be performed on the defibrillation connectors only. If defibrillation is performed over one or more of the ECG connectors, high voltages may be present on the remaining connectors during the shock. Defibrillation attempts via the ECG connectors will also damage the internal electronics requiring that they have to be replaced.
- To prevent overheating, do not provide more than three (3) defibrillator discharges (max 360J) in a sequence. Do not exceed an average of two (2) defibrillator discharges per minute during the training session.
- The manikin must not be in contact with electrically conducting surfaces or objects during defibrillation. A flame-supporting atmosphere, for example with a high content of oxygen, should be avoided during defibrillation.
- The manikin chest must be kept dry. Special attention should be taken when using IV Arm and IV/IO Leg.
- To prevent chest skin electrode pitting, do not apply conductive gel or conductive defibrillation pads intended for patient use.
- Do not use cables or connectors having visible damage.
- Do not spill fluids over any component inside the manikin torso, since this could damage the unit and might also present a possible hazard for the operator.

This device generates uses and possibly radiates radio-frequency energy. If it is not installed and used in accordance with the instructions, it may cause harmful interference to radio communications. In that case the user is encouraged to attempt correction of the interference by:

- Reorienting or relocating the receiving antenna.
- Increasing the distance between the device and receiver.
- Connecting the device to an outlet on a circuit different from that to which the receiver is connected.
- Consulting the dealer or an experienced radio/TV technician for help.

Latex

The veins in the IV Arm and in the lower legs, and Pneumothorax bladder contain latex. Users who suffer from latex allergy should take precautions while using or handling the latex parts by wearing non-latex protective gloves.

Approvals:

 The product is CE-marked and in compliance with essential requirements of council directive 89/336/EEC; EMC – directive.

Contents

Cautions and warnings	2
Introduction	3
Items included	4
Getting started	4
In use	7
After use	11
Maintenance	11
Trouble shooting	13
Technical data	13
Parts / Accessories list	14

Introduction

SimBaby is a full-scale simulator with realistic anatomy and clinical functionality that enables simulation training. SimBaby includes software with video debriefing and an interactive technologically advanced manikin allowing learners to practice the emergency treatment of patients.

SimBaby is a full body, 6 months old infant manikin that allows the simulation of a wide range of skills and assessment to develop both individual and team skills.

The simulator allows observation and recognition of most vital signs which are used in emergency medicine either directly on the manikin itself or on the included simulated Patient Monitor. When used correctly, these features will support the students' competence ability to reach the correct diagnosis based on active observation as opposed to being prompted by instructor cues.

The patient monitor also doubles as display for other functions, such as display of 12-lead ECG and X-rays.

The manikin allows for most relevant medical intervention to be performed according to their medical guidelines and protocols. The Laerdal SimBaby contains an advanced airway allowing for simulation of difficult airway management cases. The anatomy can be changed during the scenario to indicate changes to the patient condition or as a response to students' intervention. Correct form and technique are required to perform direct laryngoscopy and endotracheal intubation. Correct use of a variety of airway adjuncts will successfully ventilate the patient simulator.

The simulated patient monitor is a replication of the Philips IntelliVue patient monitor, which includes the ability to set up the screen layout in various ways. It also allows configuration outside the IntelliVue's features to mimic other patient monitor types as well.

SimBaby is operated through a Software (SW) which runs on a PC. Interaction with the SW is done through a Graphical User Interface (GUI) where the various vital signs parameters are changed directly or through pre-programmed scenarios. The SW also allows automatic and manual logging of scenario events as well as video capture. The events logged during a scenario can be shown in a debrief viewer together with video capture. The log is synchronized with the video capture. This allows the instructor to review both the log and actual performance during debriefing. The debrief can also be stored for later review.



Items included

The Laerdal SimBaby includes the following main components:

- Laerdal SimBaby Manikin
- SimBaby Software CD-ROM
- Presentation CD-ROM: Set-up/Features/Configurations
- SpO₂ Pulse Oximetry Probe
- Set of plates for Manual Defibrillation
- Airway Lubricant
- Esophagus filter assy (50)
- Pneumothorax Kit, consisting of:
 - Extra Pneumothorax Bladder
 - Extra Pleura Sleeves (10)
 - Extra Chest Skin
- IV/IO Kit, consisting of:
 - Tubing, arm
 - Extra arm skin
 - Lower IV/IO leg right
 - Lower IV/IO leg left
 - Simulated Blood Concentrate
 - Blood system
- Talcum Powder
- Blood Pressure Measuring Kit

Additional items required for use: (configurations vary)

- Laptop computer
- USB Camera
- Simulated Patient Monitor
- USB Hub
- PDA
- Link Box

Connection Cables and Tubing, consisting of:

- Power supply, Simulated Patient Monitor
- AC Line Cord, Link Box
- Cable, Link Box to Manikin (15-pin)
- Cables, PC to Simulated Patient Monitor (signal and USB)
- Cable, Link Box to PC (9-pin)
- Cable Audio, PC to Link Box and Patient Monitor
- Hose, Manikin Air and CO₂ Supply

Pressurized Air and CO₂ source

(to be purchased separately if not included):

- Compressor Unit (included in some configurations) or Regulator Unit

Getting started

(See also Presentation CD-ROM included with the SimBaby or www.laerdal.com for details regarding connections)

Link Box

The Link Box connects the manikin to the computer.

To connect:

- 1) Attach manikin cable to right lower side of manikin's torso and to the connector marked "Manikin" on the back of the Link Box.
- 2) Connect serial cable to connector marked "PC" on the back of the Link Box and to serial port on back of your computer.
- 3) Connect clear tubing from blood pressure cuff to the inlet marked "BP cuff" on the back of the Link Box.
- 4) Connect the SpO₂ cable to the SpO₂ connector on the back of the Link Box.
- 5) Connect one end of the audio cable to the connector marked "Audio input" on the back of the Link Box and one to the Patient Monitor, and the other end with the mini-jack plug into the headphone outlet of your computer.
- 6) Plug the Link Box AC power cable into a power supply (110-240 V AC). If you are using the Portability Kit, attach to the 12 V DC input according to the Portability Kit instructions.
- 7) Connect external speakers, if used, to connector marked "Ext. speaker" on back of Link Box (external speakers not included).

USB Hub

Connect the USB Hub to one of the USB connectors at the back of the PC. Attach the AC adapter to the USB Hub and to a wall outlet (110 or 230-240V AC).

USB Camera

The USB Camera provides enhanced debriefing possibilities. Follow the installation instructions on the camera packaging. The Camera is connected to the PC using a USB connector. Video input is synchronized with the SimBaby application, providing replay combined with log. For set-up of the camera, see the installation guide provided with the camera.

SpO₂ Probe

The SpO₂ probe provides enhanced realism for the care provider by simulating the use of an actual pulse oximetry probe. When the probe cable is connected to the Link Box, SpO₂ will not be displayed until the probe is placed onto the manikin. If the probe is not attached to the Link Box, SpO₂ will only be displayed automatically when selected by the user through the instructor panel on the PC.

Simulated Patient Monitor

The Simulated Patient Monitor allows any or all of the patients' status data (ECG, Heart Rate, Arterial BP waveform, NIBP, Temperature, SpO₂, CO₂, CVP etc.) to be displayed. To connect, attach the monitor cable to the PC's monitor connector, the USB cable to one of the USB connectors or to the USB Hub, and the Audio Cable as described earlier under "Link Box". Plug the Simulated Patient Monitor power cable into a power supply (110 V or 230-240 V AC). The Patient Monitor has to be calibrated the first time of use. See the Install Guide for more information.

Blood system

The blood system includes a blood bag and three tubes with valves that can be connected to the veins in the arm and both legs. The "blood pressure" in the system can be altered by moving the blood bag up or down.

Air and CO₂ Source (optional)

Option 1: Compressor Unit

If you have purchased Laerdal SimBaby with a Compressor Unit, attach one end of the double lumen hose into the compressor and the other to the hose that comes out of the manikin.

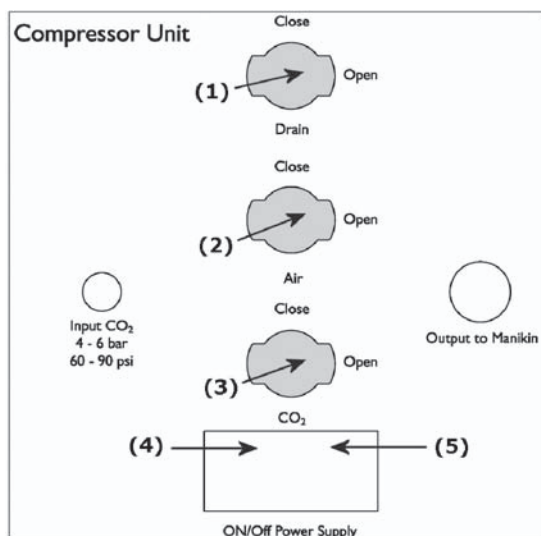

Start procedure:

1. Check that Power switch (4) is set to off position "0".
2. Plug power supply cable into plug (5) in Compressor panel.
3. Plug power supply cable into power source.
4. Connect CO₂ supply to the "Input CO₂" connector using the black hosing attached (optional feature).
5. Check that Drain valve (1) is closed.
6. Close Air valve (2) and CO₂ valve (3).
7. Push Power switch (4) to on position "1", the Compressor will start and run for approx. 45 seconds to build up pressure in tank.
8. When Compressor stops, you can start to use the manikin. Open the Air valve (2) and the CO₂ valve (3).
9. The Compressor will start and stop with different intervals depending on consumption of air.

Stop procedure:

1. Push Power switch (4) to off position "0", the Compressor will stop if it is running.
2. Close Air valve (2) and CO₂ valve (3).
3. Open Drain valve (1) and drain air out of system.

Warning:

Do not open Compressor box when energized, dangerous voltage inside. To be opened by authorized personnel only.

Important:

If the Compressor Unit is stopped manually with the on/off switch, the air tank has to be drained before restart.

Option 2: Regulator Unit

If you have purchased Laerdal SimBaby with the Regulator Unit, attach one end of the double lumen hose to the "Air/CO₂, out to Manikin" outlet on the regulator and the other to the hose that comes out of the manikin.

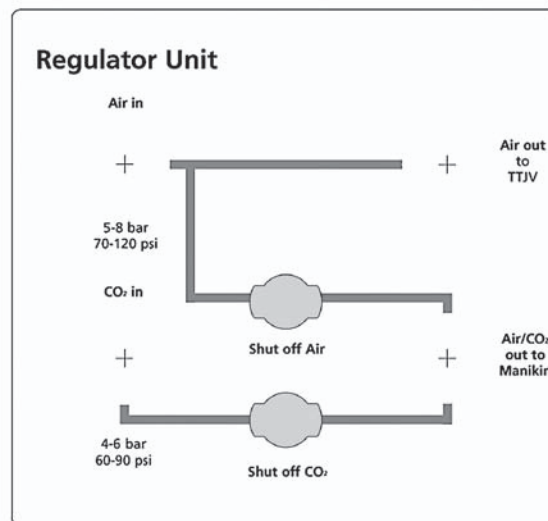

Start procedure:

1. Close Air valve (Shut off Air) and CO₂ valve (Shut off CO₂).
2. Connect Air supply (5-8 bar) to the "Air in" connector using the blue hosing attached.
3. Connect CO₂ supply (4-6 bar) to the "CO₂ in" connector using the black hosing attached (optional feature).
4. Open Air valve (Shut off Air) and CO₂ valve (Shut off CO₂).

Stop procedure:

Close Air valve (Shut off Air) and CO₂ valve (Shut off CO₂).

Important:

Never leave the manikin with pressurised air present in the hose as this may ruin some of the manikins functions.

Operating software

The SimBaby Software serves as the instructor's tool for controlling the training scenario. It requires the following:

- Type Dell Latitude D600 or similar
- Processor: Minimum Pentium M 1,8 GHz or better
- Hard drive: 60 GB minimum
- RAM: 512 MB minimum
- System : Windows XP Pro
- Screen: Dual Screen with min. 1280 x 1024
- Mouse: Two (2) button scroll wheel mouse
- Other: CD-RW, RS-232 (serial port), 2-4 USB ports, Internal Bluetooth, Microphone input, Headphone output

For software installation, see instructions included in the Install Guide. The software features are:

- Training controls via computer keyboard, mouse and/or PDA
- Variable extrasystole rate and choice of various extrasystole types
- Variable pacemaker threshold (external pacemaker training only)
- Control of manikin functions
 - Airway complications
 - Tension Pneumothorax
 - Breathing
 - BP - NIBP and Arterial
 - SpO₂ simulation
 - Fontanell
 - Temperature display
- Auscultation sounds
 - Lung
 - Heart
 - Bowel
- Vocal sounds
 - Numerous vocal sounds are available (crying, hicup, etc.)
 - Additional sounds can be recorded by the user
 - Microphone option (instructor may speak directly through the manikin's head speaker by using a microphone)
- Left/right or bilateral lung obstruction
- Pulse strength
- Activity Log
- Scenario Builder
- Trend Editor
- Event Handler
- Debriefing including activity log synchronized with video and monitor pictures

PDA remote control

A personal digital assistant or PDA is used as the remote control. The PDA communicates with the software via Bluetooth. A PDA User Guide is included with the manikin. Refer to this guide for additional information.

Simulated Patient Monitor

The Simulated Patient Monitor is connected to the PC (laptop). It is a touch screen monitor that provides concise clinical feedback of physiological parameters. All parameters are instructor-activated with the ability to set a lower and higher alarm limit for every parameter shown on the monitor. The monitor may be configured to display the desired parameters and curves and it is possible to save and retrieve five (5) configurations. Colors and curve trace speeds can also be changed. The CO₂ curve has by default a slower trace speed. Because all information is simulated rather than actual, the parameters, with the exception of ECG, cannot be "measured or displayed" on clinical equipment. For additional information, refer to the software helpfiles.

The monitor provides the following output (synchronized with all other clinical outputs)

- Arterial blood pressure waveform
- CO₂ and capnograph waveform
- Heart rate related to SpO₂
- BP – with timed automatic updating and 'BP now' function
- Respiratory rate
- Temperature
- SpO₂ waveform and numerical display with audio output
- CVP waveform and numerical display output
- PAP and Wedge
- TOF
- TOF%
- CO
- FIO₂
- FIN₂O
- FI Anesthetic agent
- ETO₂
- ET Anesthetic agent
- Core temperature
- Peripheral temperature
- Monitor trends
- 12-lead ECG with adjustable ST-elevation and conduction on some rhythms
- X-ray

Calibrating the Patient Monitor

Because the Simulated Patient Monitor uses touch-screen technology, it must be calibrated before use. To calibrate the monitor:

1. Double click the "elo" logo in the system tray in the lower right corner of the screen.
2. Click on the "Align" button in the dialog box
3. If target indicators appear first on the instructor computer screen and not on the patient monitor, press "Esc" or wait until they appear on the patient monitor.
4. Touch each target as it appears on the Patient Monitor
5. Touch the green check mark after all targets have been touched.

USB Camera

The USB Camera provides enhanced debriefing possibilities. Video input is synchronized with the SimBaby scenario log. To set-up the camera, see Install Guide and Directions for Use included in your camera packaging.

Important:

Connect the camera via a USB port directly on the laptop. Do not use the hub as this may cause interference.

In Use

Head

The infant head offers realism by including an anatomical correct cervical neck that offers a realistic range of flexibility.

The head allows for performance of head tilt and jaw thrust maneuvers. Bulging fontanel can also be simulated. The eyes have interchangeable pupils for simulation of three different pupil sizes - contracted, normal and dilated.

Airway and Lungs/Stomach

a) Airway anatomy:

The infant manikin provides an anatomical realistic upper airway including:

- Oropharynx
- Nasopharynx
- Laryngopharynx
- Carina
- Trachea

b) The manikin simulates spontaneous respiration with the following features:

- Chest rise and fall
- The variable respiratory rate is synchronized to the Simulated Patient Monitor display and lung sounds
- The tidal volumes dynamically alter in line with the selected respiratory rate

c) SimBaby accepts a wide range of airway management devices and techniques. Some examples are:

- Bag-Valve-Mask (BVM)
- Oral/nasal pharyngeal airways
- Endotracheal tubes - nasal and oral [recommended ET tube size is 3.5. We also recommend the use of a malleable stylette. Care should be taken, that the stylette does not extend beyond the end of the tube, as with any direct intubation.]
- Laryngeal Mask Airways (LMA) [The Laerdal SimBaby will allow use of the LMA Classic and LMA Unique. Recommended size is 1.5.]
- Fiberoptic procedures
- Nasogastric tube insertion
- Correct form and technique are required to perform direct laryngoscopy and Endotracheal intubation
- Correct use of a variety of airway adjuncts will successfully ventilate the patient simulator

d) The manikin contains two lungs. Too deep intubation will result in unilateral lung filling. This usually occurs on the right side, due to the accurate anatomical modeling of the tracheobronchial junction.

e) The system does not accept PEEP modes of ventilation.

f) Mouth-to-mouth/nose/mask ventilation shall not be performed on SimBaby due to cleaning issues.

g) The airway contains a number of instructor-controlled airway complications.

Using the computer user interface (or the PDA), the following airway functions can be activated and deactivated:

- Pharyngeal Obstruction
- Tongue Edema
- Laryngospasm
- Decreased Lung Compliance
- Increased right and/or left lung resistance
- Pneumothorax
- Stomach Decompression
- Exhale CO₂
- Variable breathing rate

- Variable breathing pattern
 - See-saw breathing
 - Subcostal retractions
 - Unilateral breathing
- Apnea
- Variable pulse oximetry display
- Breath sounds

Important:

Prior to using airway adjuncts, spray all airway management devices to be inserted with a small amount of the provided airway lubricant. Use only a very liberal amount of airway lubricant in the manikin's airway. Make sure to replace the Esophagus filter after every session/course if airway lubricant has been used.

Torso

a) Anatomically modeled from live babies, the torso demonstrates normal anatomical surface landmarks.

b) SimBaby has correct anatomical landmarks for external chest compressions. Chest compressions will produce compression artifacts on the Simulated Patient Monitor and palpable pulse.

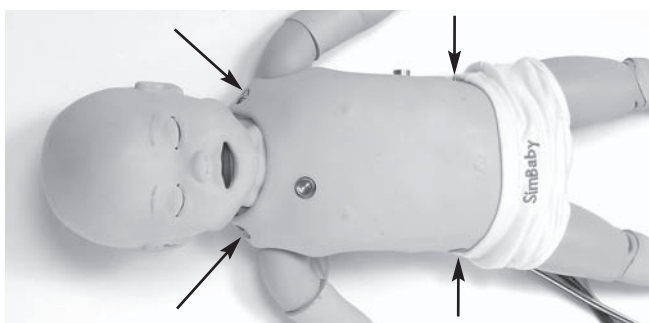

c) Manikin is equipped with separate defibrillation and ECG monitoring connectors. The system provides real 3-lead ECG readings (4 connectors).

Note: The ECG connectors are designed for ECG monitoring only. If defibrillation is attempted over any of the ECG connectors, high voltages may be present on one or more of the uncovered connectors during the shock. (See the "Cautions and Warnings" section.) Defibrillation attempts via the ECG connectors will also damage the internal electronics requiring that they have to be replaced.

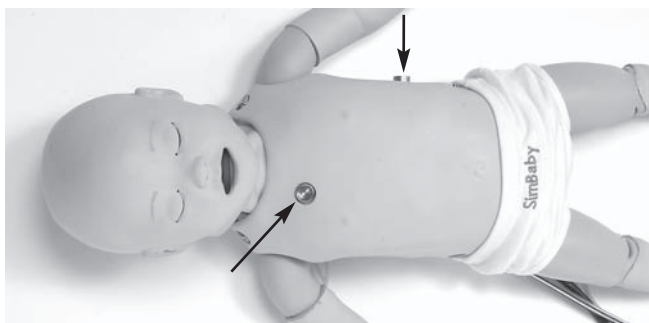

d) Manikin is equipped with two defibrillation connectors. ECG signal can also be monitored across these connectors. Instructor can select, via appropriate keyboard command, the "Ignore Defib" function. This determines if the defibrillation shock results in conversion to a selected waiting rhythm. Manual paddle adapters (Manual Defib. Plates) are supplied for use with manual defibrillators.

Note: Defibrillation must be performed only over the two defibrillation connectors. (See the "Cautions and Warnings" section.)

e) Connectors for external pacing are connected to the manikin's defibrillation connectors. Patient pads should not be used, as they do not guarantee sufficient contact. The system has a variable pacing threshold and the ability to "ignore" pacing. Pacing capture results in a pulse synchronized with the heart rate and the display of a paced rhythm on the Simulated Patient Monitor.

Pneumothorax

Pneumothorax on left side can be simulated through the software. The students will then see unilateral chest rise on the manikin.

a) Chest Drain / Chest Tube

Chest Tube insertion can be performed at the left mid-axillary site. A cut can be made at left mid-axillary line at the (4th and 5th intercostal space.

b) Needle Decompression

Needle decompression can be performed at the left mid-clavicular line, 2nd intercostal space. We recommend a 22-gauge needle for decompression of the chest. Using a smaller gauge needle increases the longevity of the chest skin and bladder.

Sounds

The torso contains a number of hidden speakers that allow the realistic auscultation of sounds:

- Lung, left and right
- Heart, upper and lower

Abdominal distension

Abdominal distension occurs with too high ventilation pressure while using Bag-Valve-Mask. NG Tube can be inserted. Operator needs to activate gastric distension through the software to release the air from the stomach.

Body movement

Body movement can be simulated and requires that the manikin lie onto a rigid base. Place a piece of cardboard or equal under the manikin if the manikin is placed on a soft surface (bed, mattress etc.).

Pulses

a) SimBaby has palpable pulses:

- Bilateral femoral pulse
- Left radial and brachial pulse

b) The pulses are synchronized to the simulated ECG and, when activated, the external pacemaker upon capture.

c) Pulses, once activated, will remain on for approximately five (5) seconds before reactivation is required.

Note: Care should be taken when palpating pulses. Use of excessive force results the inability to feel pulse.

Arms

a) Blood Pressure Arm

Left Arm is a Blood Pressure Arm with radial and brachial pulses and Korotkoff sounds. Blood pressure can be measured using the supplied blood pressure cuff attached to the link box and installed onto the left arm (BP Arm) brachial position.

Blood pressure settings are controlled using the computer, and linked to the ECG functionality, so if you are changing the rhythm from a perfusing rhythm to a non-perfusing rhythm, this will also be reflected on the blood pressure settings, which will be changed according to the new type of rhythm. A non-perfusing rhythm will change breathing rate (BR) to zero. When changing to a perfusing rhythm, the blood pressure will remain at 0/0 until changed;

breathing rate cannot be changed until blood pressure has been established.

Auscultation gap can also be simulated.

b) IV Arm

Right Arm is dedicated to IV skills and allows:

- Cannulation
- Phlebotomy
- Drug administration
- Infusion

The veins are self-sealing allowing multiple uses; however, repetitive insertions in the same area will result in leakage sooner than if the cannulations had been spread over a wider area. Using smaller size needles will also extend the "life-time" of the veins. The venous system and the skin sleeve are both replaceable.

The IV arm can be used with simulated blood by attaching one of the supplied blood system tubes to one of the two latex vein openings near the top of the arm. Using the supplied simulated blood concentrate, mix the desired volume of simulated blood and add to the IV bag (see procedure below). Release simulated blood until it runs via the tubing into the arm and out the other latex vein. Once fluid is running freely out of the second vein, seal it using a clamp. Using a 22 gauge (or smaller) needle for IV training increases the life of the IV arm skin. If you want the student to infuse medicines, attach a second IV bag for free flow.

Legs

Both legs have IO and IV access with replaceable lower legs that include the IO and IV access points. The IV/IO legs can be used with simulated blood. Using the supplied simulated blood concentrate, mix the desired volume of simulated blood with water and add to the IV bag (see procedure below). Before IV/IO practice can start, fill the lower legs with simulated blood. Use a syringe and fill the lower legs through the drain plugs at the back of the lower leg (drain plug to be the highest point to avoid air remaining in the leg). Attach two of the supplied blood system tubes to the latex veins openings near the top of the lower legs and release simulated blood until it runs via the tubing into the legs (make sure the drain plugs are not closed before this procedure is done). Close drain plug when fluid is running freely. Using a 22 gauge (or smaller) needle for IV training increases the life of the IV leg skin and vein. For IO training a 14 gauge (or smaller) needle is recommended. Replace the lower leg after each course if used for IO cannulations.

Procedure for filling Blood Bag (IV Bag)

Use a syringe to inject fluid into IV bags, and fill to desired level. Control flow of blood into arm and legs, via valves.



Air and CO₂ Source

Compressed air is provided by a compressor or other type of pressurized air source via a regulator unit, allowing many functions to take place:

- Airway complications
- Spontaneous breathing
- Tension pneumothorax inflation
- Carotid pulse

The compressor unit operates at 110 or 230 – 240 V AC. It can be connected to a CO₂ source for exhaled CO₂ to take place.

Starting the software

The SimBaby SW is started by clicking the SimBaby icon on the computer desktop. After entry of password (optional) and selecting a profile, the SimBaby starts up in the default mode which represents a patient in a healthy state. If the web camera recording is enabled, you will be prompted to start the recording. For more information on this feature, refer to the section on video recording later in this document or to the help files.

Operating software

The operating software is controlled via a Graphical User Interface (GUI). The GUI displays an overview of the current status of simulated patient's vital signs, the control functions for modifying these, and a time-based log of the events which has occurred during the scenario.

The patient simulator can be operated in three manners;

- Manual mode,
- Semi-automatic mode
- Automatic mode

Manual mode

In manual mode the vital signs parameters are changed directly through changing the values one-by-one based on the desired change of the patient condition.

The various vital signs parameter can be changed directly on the GUI in the following ways. For detailed description, please see help files under "Help" in GUI's Program Menu Bar.

- To change values in the "Instructor Monitor Control Center" (upper right corner of the GUI); click on the parameter and set the new values, or rotate the mouse wheel while the cursor is over the numerical values.
- To change values in the "Airway and Circulatory Control Centre" (center section which includes a torso illustration), by click directly on the parameter which is to be changed and select the new state, or use the slider bars.
- To change values in the "Respiratory Control Center" and "Difficult Airway Control Center" (upper left corner) by select state or use the slider bars.

Semi-automatic / Automatic mode

In semi automatic / Automatic mode the change to multiple vital signs parameter can be pre-defined as "trends". These trends can then be activated one by one directly or multiple activated via the "event handler" function. Trends allow the instructor to introduce physiologic situations into the simulation. A brief overview is shown below, for more information refer to the help files.

To use pre-programmed or saved trends:

1. select the "Start/Stop..." button located in the Trends box in the main window
2. select the desired trend
3. click the start button.

To build and save new trends:

1. select "Start Trend Editor" from the Edit dropdown menu
2. select the parameter to be included in the physiologic model of the trend you wish to design
3. click "ok"

Automatic mode, creating and using scenarios

In automatic mode, scenarios which includes multiple alternative and consecutive changes to the vital signs can be pre-defined. The scenarios can be constructed so that the change from one condition to the next may have multiple outcomes. The various outcome alternatives has been defined in the scenario and triggered by pre-defined events. These events may be either automatically registered events such as "time" or a defibrillator shock, or by manually entered events such as administration of drugs.

SimBaby is delivered with a set of pre-programmed scenarios. Pre-programmed or saved scenarios can be started, paused, halted or debriefed from the "Scenario Control Centre" found in the lower left quadrant of the GUI.

To start a scenario:

1. click "Start Scenario"
2. select a simulation case to run

To temporarily halt the scenario, click on the pause (⏸) symbol.

To resume a simulation that has been paused, click on the play (▶) symbol.

To halt a scenario, click on the halt (■) symbol.

Before creating a new scenario, it is important to understand the difference between Events and Actions.

Events

Things that happen outside of a scenario, usually caused by students, are called "Events." The ABC/Miscellaneous/Medication events in the main window are also called "Scenario Events." There are also "Time Events" caused by either of the two timers reaching a predetermined limit

Actions

In a scenario, "Actions" are performed by the scenario. For example, changing a parameter value, creating an airway complication and making vocal sounds are "Actions" performed by scenarios.

To create a new scenario:

1. Choose "Start Scenario Editor" from the Edit dropdown menu then
2. click the new scenario (📄) button

The scenario is constructed from a set of frames. Each frame represents a state of the patient. The scenario can only operate in a single frame at any given time. The scenario moves to other frames as events specified in the "Events field" occur. To control which frame the scenario moves to, connection lines are drawn from each event box to the desired frame. When the specified event occurs, the scenario moves to the corresponding frame. For a more detailed description, refer to the software help files.

Saving Scenarios

To save a new scenario:

1. Select "File" from the dropdown menu
2. Enter the name of the scenario
3. Click the "Save" button.

To retrieve the file at a later time:

1. Click the "Start Scenario" button on the GUI
2. Select your saved scenario

Debriefing during or after a scenario

The debriefing function is available both during and after scenarios. To activate the debrief view, click on the "Debrief" button. If you are currently running a scenario, this action will automatically pause your running scenario and take you to the debrief screen. After you have reviewed the log, you can choose to save the debrief or return to the scenario without saving. To exit, select "Exit" from the file dropdown menu and follow the prompts to save or exit without saving as desired. If you paused a running scenario, click on the play (▶) button from the main SimBaby GUI to resume the simulation. For more information on the Debrief viewer, refer to the help files.

Halting the scenario

When a scenario is running, clicking the halt (■) symbol will put the scenario in manual mode. The software will confirm that you want to stop the scenario. After a "yes" response the word "Halted" will appear on the screen. The scenario continues to run but all operations must be carried out manually by the instructor. To fully stop and save a scenario, click the debrief button. When the debrief viewer appears, choose "Save As" from the "File" dropdown menu.

Instructor Monitor Control Centre

The instructor can manipulate the values of the monitor parameters from the Instructor Monitor Control Centre which can be found in the upper right quadrant of the main GUI. Adjustments can be made to any of the physiologic values by pointing the mouse over the desired area and clicking. Windows will open allowing the instructor to select and apply the desired changes and functions.

Configuring the Patient Monitor and Simulator and Creating Profiles

General configurations for both the simulator manikin and patient monitor can be controlled via the GUI. To configure:

1. Select "Configure" from the "Edit" dropdown menu
2. Select either the "General" or "Patient Monitor" tab.
3. Double click on the appropriate icon to enter submenus.
4. Make desired changes
5. Select "ok" to initiate the change.

If you have changed the configuration, the software will ask you whether or not you wish to save the changed configuration, try it without saving or cancel the operation. If you choose "yes," you will be asked to name the new profile you created. A space is provided for additional comments. To open a saved profile, follow the steps shown above to open the configuration window then select "Open profile."

Edit the Patient Monitor Set-Up from the GUI

The patient monitor can be edited to replicate different healthcare institutes and clinical environments thus increasing realism during scenarios. To access the patient monitor set-up:

1. Open the "Edit" dropdown menu
2. Select "Edit Monitor Set-up..."

A window will open showing the standard patient monitor configurations. Refer to the help files for a detailed description of the different configurations.

Choose Monitor Set-Up Using View

The patient and the instructor monitor can be individually configured. Click on "View" to show the dropdown menu. The default settings shows "Instructor = Monitor" checked, indicating both displays are the same. If different settings are required, uncheck "Instructor Monitor - Patient Monitor"

To select the desired monitor configuration:

1. Click "view"
2. Select "Patient Monitor Setup..." or "Instructor's Monitor Set-up" from the view dropdown menu.
3. Select the desired monitor configuration and click "open" to activate the new configuration.

Video recordings

SimBaby utilizes a webcam for recording the students' performance during a scenario. For a complete debriefing experience, the recordings can be integrated into the debriefing guide.

To set-up the camera for video recording, follow the instructions provided in the "Install Guide." Be sure to note that the camera should be connected directly to a USB port on the back of the laptop. Do not use the hub as this may cause interference. Select the "Video Recording Configuration" from the "Edit" dropdown menu then make your selections and press "ok".

Note: Video will be stored on the hard drive of the instructor's computer.

PDA remote control

The PDA comes pre-installed with some SimBaby configurations. If your PDA is pre-installed, turn the PDA on and select the SimBaby Pocket icon from the Programs menu to start the PDA application.

If your PDA has not been pre-installed, refer to the SimBaby/SimMan PDA User Guide included with your simulator for complete installation instructions.

After use

- Be sure that compressed air is not present in the manikin when training session is over.
- Clean manikin skin with mild soap and water. Make sure that no water comes inside the manikin. Do not submerge manikin.
- Clothes can be hand or machine washed with soap or laundry detergent in warm water, max. 60°C (140°F). Iron with warm iron. May be dry cleaned. Please note that hot air dryer may cause garment shrinkage.
- Modules and all other parts shall be drained, flushed through with water and air-dried thoroughly prior to storage. Disinfectants should be used when appropriate.
- Replace Esophagus Filter assy after each session (see Maintenance section for details).
- Replace lower legs if IV/IO skills have been practiced.
- Store properly between teaching sessions. If stored in hard cases disconnect cables and tubings.
- Air filter in compressor should be replaced every two years. Directions for replacement are part of the Technical/Service manual.

Maintenance

Tension Pneumothorax Decompression—left Mid-Clavicular site To replace bladder:



- 1) Remove skin at torso sides and loose inside tap at the umbilical area from its seat.
- 2) Lift the chest plate assy exposing its underside.

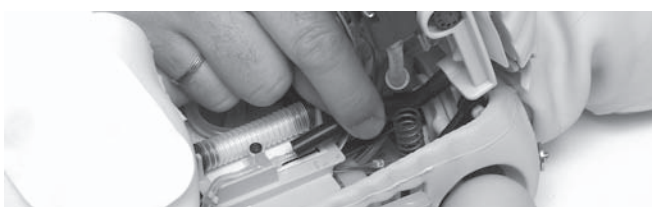

- 3) Disconnect bladder hose from the nipple.



- 4) Remove bladder from site cavity by sliding it sideways out of the chest.

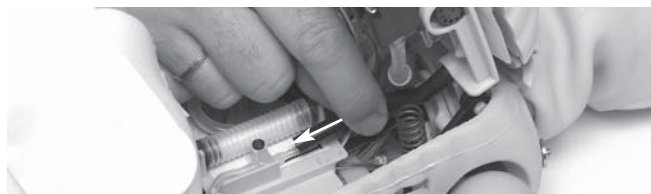

- 5) Insert new pneumo bladder into site cavity and reconnect to the nipple.
- 6) Replace chest plate assy.
- 7) Replace chest skin over torso, fasten the tap inside the skin to its seat and secure skin at the shoulders and both sides.

Chest Drain - Left Mid-Axillary Site

To replace pleura sleeve:

- 1) Loose chest skin at left side or remove chest skin (see procedure above).

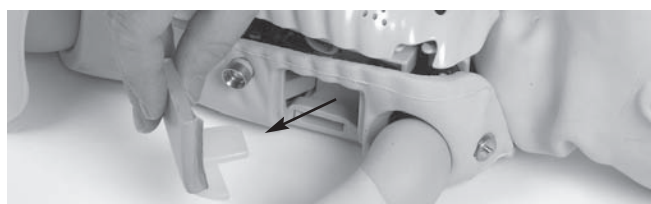

- 2) Remove chest tube insertion module from mid-axillary side of manikin.



- 3) Replace the pleura (foil) sleeve.
- 4) Put chest tube insertion module back into the torso.
- 5) Secure chest skin or replace with a new skin (see procedure above).

Esophagus filter assy

After each session/course the esophagus filter assy shall be replaced by a new one.

- 1) Remove chest skin (see procedure above).

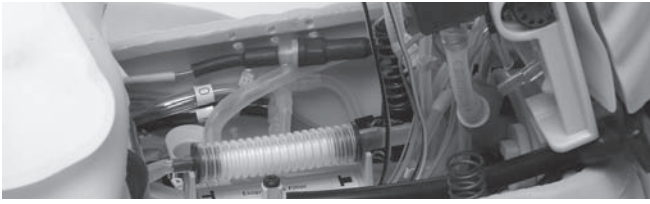

- 2) Lift the chest plate assy exposing the internal parts and find the filter holder (see figure).



- 3) Disconnect the filter assy and replace by a new one.
- 4) Replace chest plate assy and chest skin (see procedure above).

Pupils

There are three extra sets of eyes included with the manikin; normal (default with the manikin), contracted and dilated..



If you want to add some of the attached pupils to the manikin, open up the eyelids with your fingers, remove the installed pupil from its seat using the eye lens replacement device included and install the desired pupil into its seat using the same tool.

IV Arm

When excessive leaking occurs at the puncture sites, a new vein and skin should be installed to reduce loss of fluid.

To replace the vein:



- 1) Pull the skin and vein off the arm. While doing this make sure you hold the manikin's shoulder (not the torso) with your other hand.

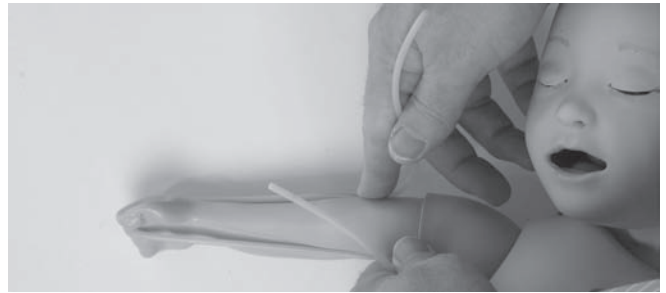

- 2) Route a new vein along the groove in the arm, leaving the two ends of approximately equal lengths. Support the vein so it does not fall out of the groove while you pull on a new arm skin.



- 3) Slide a new arm skin over the arm and vein. Make sure that the two holes line up with the ends of the groove close to the shoulder. Use of talcum powder may ease this procedure.

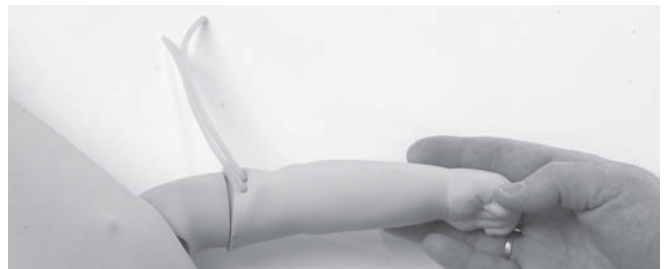

- 4) Pull the open ends of the vein through the holes in the arm skin.

IV/IO Leg

When excessive leaking occurs at the IV/IO puncture sites, the lower leg should be replaced by a new one.

To replace lower leg:



1) Press the bolt in the knee part out of its seat.



2) Replace the lower leg by a new one.



3) Secure the leg by pressing the bolt into its seat.

Trouble shooting

If your system does not work check that set up is correct according to "Getting started" section.

Technical data

Power consumption:

Link box and manikin	Input 110/230V AC	1.4A
	Output 12V DC	5.0A

Patient Monitor (power supply)	Input 100-240V AC	50W
-----------------------------------	-------------------	-----

Compressor unit	Input 110V AC	1.9A
	Input 230V AC	1.0A

Air consumption:

Compressor air outlet	1.1 bar +/- 10%
Compressor CO2 outlet	0.7 bar +/- 15%

Weight and size:

SimBaby manikin	4kg (8.8 lbs)	65x23x16cm
Compressor	14kg (30.8 lbs)	35x43x24cm
Regulator unit	1.5kg (3.3 lbs)	20x16x11cm
Patient monitor	9.6kg (21.1 lbs)	44x44x24cm
Link box	2.4kg (5.3 lbs)	21x10x22cm

Environmental condition:

Operating temperature	+10C to +40C
Storage temperature	-15C to +50C
Humidity	15 to 90% RH (non-condensing)

Parts / Accessories List

Accessories

1005146	Tubing Assy 40ft Compressor-Manikin, Air/CO ₂
1005164	Cable Assy 25ft, Manikin-Link Box (15-pin D-sub)
210-01050	Compressor 230 V
210-01150	Compressor 110V
381220	Regulator Unit for Fixed Air Supply
381850	Portability Kit
245-19550	Technical/Service Manual
245-18050	Transportation case (for patient monitor etc.)

Consumables

100019	Blood Concentrate, 100ml
250-21050	Airway lubricant, 45ml (glycerol version)
245-12150	Skin & Vein, IV Arm
245-13250	Pneumothorax Bladder (pkg.5)
245-13150	Pleura for Chest Tube Module (pkg.10)
245-11650	IO/IV leg lower left (pkg.3)
245-11150	IO/IV leg lower right (pkg.3)
245-16850	Esophagus filter assy (pkg.50)
254-11350	Blood system

Spare Parts

260305	Power-cord (US)
260306	Power-cord (EUR)
260307	Power-cord (UK)
271500	Cable 9-pin D-sub (PC to Link Box)
245-16350	Cable 15-pin D-sub (Link Box to Manikin)
380100	Link box
245-12550	Arm Assy, Blood Pressure
245-12650	Cuff Assy, Blood Pressure
380410	Defib studs set
245-13050	Chest Skin
245-12050	IV Arm, right
381010	Tubing Assy, Compressor-Manikin, Air/CO ₂
245-10050	Head Assy
245-10150	Head Skin
245-16750	Audio Cable
245-11250	SpO ₂ Pulse Oximetry Probe
245-19050	Directions for Use
245-10250	Eyes set
245-98050	USB Hub
245-96050	USB Camera
245-99033	PDA



Laerdal

helping save lives